

## Futaba<sup>®</sup>



### 4PX

4-Channel 2.4GHz T-FHSS Radio

Pages 4-5

**PLUS:**

**Flyzone<sup>®</sup> Beaver Island Wings Select RxR**  
Pages 8-9

**ARRMA<sup>®</sup> Kraton 6S BLS 1/8 4WD RTR**  
Pages 6-7

**Great Airplane Rebate**  
Pages 22-23

## 2013 CHALLENGER SRT8



Pages 2-4



**PLUS:**

**New Estes<sup>®</sup> Rockets**  
Page 17

**New Plastic Models**  
Pages 4-12

**Alex Toys**  
Page 14

# Take care of your customers on the spot — we'll cover your repair costs!



## ServiceNow™

Your customers want immediate attention, and Service Now helps you give it to them. It's one more reason why — when it comes to keeping modelers satisfied — you and Great Planes make the perfect team.

Service Now simply means that we trust you to provide appropriate warranty-covered service without waiting for our authorization. If you're a Great Planes dealer, you're already eligible. Using Service Now is as easy as 1-2-3:

1. Make sure the product needing repair comes from a Hobbico brand and is under warranty.
2. Determine if a warranty-covered manufacturing defect is the cause. If so, and it can be fixed using \$50 dealer net or less in Hobbico brand parts, make the repair.
3. Complete and submit a short form (available at GPDealer.com) describing the service you provided.

That's it. We'll promptly replace the parts you used. Preapprovals are needed only for service requiring more than \$50 in parts — and then, you can get the "OK" with just a quick call or email to Hobby Services.

To learn more about Service Now, call your sales representative today at 1-800-637-7660.



# SO MUCH FUN AND TECHNOLOGY IN SUCH A LITTLE QUADCOPTER!

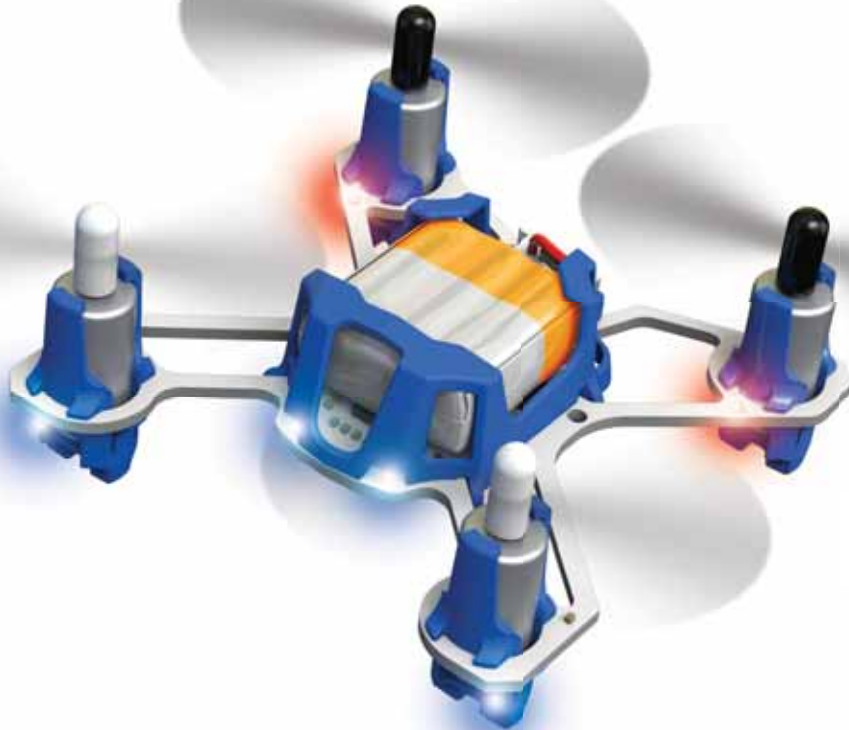

protoX<sup>SLT</sup>  
Ready-To-Fly SLT Nano Quadcopter



- Flies in any open indoor area
- The triple-axis, three-accelerometer gyro features an Auto-Upright system for self-correcting flight that keeps the Proto-X SLT stable in any flight condition
- The 2.4GHz controller links only to your aircraft, so multiple aircraft can fly together
- Link your Proto-X SLT to its 2.4GHz radio using the WaveLink™ feature. Just wave the heli to link!

- Comes with a USB charger and four spare rotor blades; just add four "AAA" batteries
- The included 3.7V 100mAh LiPo battery features charge and discharge protection
- Lights add to the fun when flying in the dark
- The colorful body is designed for easy LiPo battery installation and replacement
- With SLT protocol built-in, pilots can fly this cool quadcopter with popular radio systems like the Tactic® TTX650 (TACJ2650)

ESTE49\*\* Proto-X SLT Nano Quadcopter RTF  
Dimensions: 1.8 x 1.8 in (45 x 45 mm)  
Weight: 0.4 oz (11.5 g)  
Requires: 4 "AAA" batteries

**ESTES** Control

## From the Experts:

Toss the Proto-X SLT Nano Quad in the air, and Auto-Upright Technology keeps it level — even beginners can fly it with complete success! Secure Link Technology provides pilots with a robust connection for ultra-precise control — plus compatibility with select radios featuring the SLT protocol. And its cool looks are enhanced by 6 LEDs!

## Long story short...

*Do flips, rolls and more mild-to-wild maneuvers with the nano-sized Proto-X SLT quadcopter!*

# 4PX

## THE MOST ADVANCED SURFACE SYSTEM EVER!

www.gpdealer.com

www.gpdealer.com



**4PX**  
4-Channel 2.4GHz T-FHSS Radio

**These are just some incredible advantages of the 4PX:**

- 30% faster and 0.5 oz (15 g) lighter than the 4PKS-R
- 3.5" (89 mm) QVGA/TFT color LCD screen for fast, simple navigation and programming
- Durable, long-life wheel potentiometers
- Two adjustable throttle trigger options
- Vibration alerts
- Adjustable steering wheel position with drop-down option – can be switched for left-handed drivers
- Large, assignable switch at transmitter's bottom edge – can be activated hands-free with a body bump
- Compatible with T-FHSS, S-FHSS and FASST™ receivers
- Telemetry
- Synthesized voice for telemetry data
- Multiple crawler functions – including 4WS mixing and Dual ESC mixing
- Built-in S.Bus servo/Futaba ESC/telemetry sensor programmer
- Micro SD card slot for model storage and user updatable software
- Compatible with multiple battery types, including 2S LiFe batteries



FUTK4905 4PX 4-Channel 2.4GHz FASST/T-FHSS/S-FHSS Radio w/R304SB

**From the Experts:**

Futaba's new flagship 4PX is pretty much the fastest kid on the block, with an awesome 3.5" TFT full-color display with incredibly intuitive menus and programming. Synthesized voice, telemetry, near-perfect weight distribution, compatibility with T-FHSS, S-FHSS and FASST receivers, multiple crawler features...the list of cutting-edge features goes on and on, making the 4PX THE radio for demanding drivers!

**Long story short...**

*If you demand the best, the Futaba 4PX is the radio for you!*



# ATTACK ANY TERRAIN...WITH 6S BRUSHLESS POWER

## KRATON 6S BLX

ARRMA has done it again: this time engineering a monster truck that not only stands up to the rigors of bashing and off-roading, but one with the kind of insane speeds that will make the other monsters look like they're standing still! The KRATON 6S Speed Monster is the complete package in a high-performance 4WD truck — from the team with the goal of being #1, and the technology to take you there!



The KRATON's strength, speed and style are enhanced by a wealth of red and black anodized aluminum parts!

### High performance — Super-tough — Incredible value

#### Packed with performance features!

- ARRMA BLX 2050kV brushless motor for awesome speed
- Waterproof Receiver Box with ARRMA gasket technology
- Waterproof ESC switch system with single button programming
- Heavy-duty Gear Diffs with lightweight composite casings and tough steel outdrives
- Fully adjustable Battery Tray with hook-and-loop straps that can hold a 6S LiPo battery
- High-impact composite Suspension Arms, Steering Knuckles and Rear Hub Carriers
- Durable composite Wing Mount with aerodynamic high-speed black nylon Wing
- Steel Turnbuckle Links with race-spec adjustability
- Composite Chassis Side-Pods with built-in splash guards
- Race-spec Front Pivot Balls on upper and lower suspension arms
- Race-spec Center Differential with ultra-strong ARRMA spur gear
- Huge dBoots™ tires with aggressive all-terrain tread for maximum traction
- Ultra-wide footprint for optimum stability on any surface
- Tough, aerodynamic polycarbonate body shell with printed trim scheme
- ...and much more! To see a full list of included performance extras visit [arrma-rc.com](http://arrma-rc.com)

LiPo battery and charger not included.

ARAD81\*\* KRATON 6S 1/8 Scale Brushless 4WD Speed Monster RTR  
 Length: 23.2 in (590 mm)  
 Width: 18.5 in (470 mm)  
 Height: 7.7 (195 mm)  
 Weight: 8.8 lb (4 kg)  
 Wheelbase: 14.9 in (378 mm)  
 Ground Clearance: 1.3 in (33 mm)  
 Requires: 4-6 Cell LiPo, charger and AA batteries

**ARRMA**  
 DESIGNED FAST DESIGNED TOUGH



The KRATON 6S comes equipped and ready for action, just add the LiPo cells of your choice!

- BLX 2050kV Brushless Motor with built-in heat sink fins
- BLX180 waterproof 6S capable ESC with built-in fans and capacitors
- ATX-100 2.4GHz Radio with ARX-100 receiver
- ADS-15M waterproof, metal gear steering servo with 208 oz-in (15kg) of torque at 7.2V's

#### From the Experts:

If you want a monster truck that's as quick as it is tough, then the KRATON 6S Speed Monster is the ideal choice. Mind-blowing power and jaw-dropping speeds are what this truck is known for — especially when equipped with a 6S LiPo battery. And even with all that performance, the KRATON still handles like a dream!

#### Long story short...

*The KRATON 6S Speed Monster features unstoppable durability — and Speed is its middle name!*

# YOUR R/C FLYING ADVENTURE STARTS HERE!

## DHC-2 Beaver

Select Scale 59.5" Rx-R

www.gpdealer.com

www.gpdealer.com



Water rudders on the floats provide control for water takeoffs and landings. The conventional landing gear comes with big, tundra-style tires.



A hatch on the bottom of the fuselage provides easy access to the battery compartment. Battery shown not included.



Working navigation and landing lights add exceptional realism.



Rx-R aircraft assemble quickly and easily, while offering flexibility on receiver, battery and charger options. A powerful brushless motor, ESC and micro servos are installed to get you in the air quicker!

**FLZA4024 DHC-2 Beaver IslandWings Special Edition Select Scale Rx-R**  
**Wingspan:** 59.5 in (1510 mm)  
**Length:** 38.5 in (980 mm)  
**Weight:** 48-52 oz (1360-1470 g)  
**Requires:** 4+ channel transmitter & receiver, 11.1V 1800mAh LiPo battery & charger

- A new version of Flyzone's popular DHC-2 Beaver model!
- Boasts the scale trim scheme of the "Lady Esther", the full-size deHavilland DHC-2 Beaver flown on sightseeing tours of the Alaskan wilderness by Michelle Masden for IslandWings Air Service
- Comes with both conventional landing gear and floats
- Simple, no-glue assembly
- Working navigation and landing lights
- Equipped with a brushless outrunner motor and 40A ESC

### From the Experts:

Flyzone's original DHC-2 Beaver is a huge seller — and the IslandWings Special Edition is sure to be a big hit as well! The trim scheme replicates that of the full-size IslandWings aircraft famous for its Alaskan sightseeing tours. Larger bush tires on the landing gear allow for landing on less-than-ideal surfaces. And by swapping out with the included floats, you can perform exciting takeoffs and landings from any pond or lake!

### Long story short...

Enjoy the ease and versatility of Flyzone's DHC-2 Beaver with the IslandWings Edition — featuring a trim scheme from a real Alaskan bush plane!



# KEN BLOCK'S WR8 — NOW WITH AWESOME HPI 3.0 NITRO POWER!

## Ken Block WR8 3.0 Ford Fiesta

- A licensed replica of Ken Block's Global RallyCross Ford Fiesta H.F.H.V. in eye-catching blue and black GRC livery
- An HPI Nitro Star G3.0 delivers power to all four wheels via four-wheel shaft drive
- Tough, adjustable suspension setup with the best combination of road grip and tuning options
- The super-tough WR8 3.0 chassis is based on the Bullet 3.0 nitro monster truck
- Uses the Bullet's same tough bevel gear diffs, twin disc brakes and full ball bearing-supported 4WD shaft drivetrain
- WR8 rally-style suspension geometry, custom-designed shock towers and dampers and extra-thick sway bars deliver extra control
- Equipped with Tarmac rally tires and bright blue 11-spoke Speedline wheels



HPID2868 Ken Block WR8 3.0 1/8 Scale Ford Fiesta 4WD Rally Car RTR  
 Length: 19.1 in (485 mm)  
 Width: 8.9 in (227 mm)  
 Height: 6.7 in (172 mm)  
 Wheelbase: 11.8 in (300 mm)



### From the Experts:

R/C rally racing doesn't get more realistic than this! It starts with the licensed Ford Fiesta body that captures every detail of Ken Block's winning ride — right down to the grill and headlights up front and the double-level wing and spoiler in back. Complementing the car's scale appearance is a high-output Nitro Star G3.0 engine that delivers massive torque to the high-grip tarmac tires. And because it's Ready-To-Run, this awesome on-roader is as quick to the track as it is on it!

### Long story short...

Hit the rally circuit in style with a nitro-powered replica of the full-size Ford Fiesta racer driven by Ken Block!



AWESOME SPEED • SUPERIOR STRENGTH • INCREDIBLE VALUE

www.gpdealer.com

www.gpdealer.com



FURY MEGA  
ARAD38\*\*



GRANITE BLS  
ARAD42\*\*

EXPERIENCE THE BENEFITS:

- Priced affordably, starting at \$159.99
- Increase speeds with optional pinion gear and LiPo battery sold separately
- Ultra-tough composite and aluminum parts
- Fully waterproof electronics
- High-performance dBoots™ tires and wheels
- 100% upgradable



RAIDER MEGA  
ARAD35\*\*

VORTEKS MEGA  
ARAD36\*\*

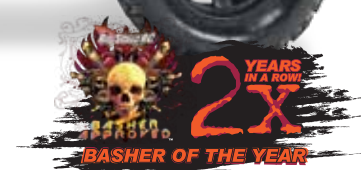

GRANITE MEGA  
ARAD37\*\*



RAIDER BLS  
ARAD40\*\*

VORTEKS BLS  
ARAD41\*\*

FURY BLS  
ARAD43\*\*



BRUSHED RTRs FOR INCREDIBLE VALUE

ARRMA  
DESIGNED FAST DESIGNED TOUGH



BRUSHLESS RTRs FOR GREATER PERFORMANCE

From the Experts:

Whether you're new to R/C or an experienced off-roader, the 2014 ARRMA lineup has the vehicles that will get your pulse racing.

Long story short...

ARRMA innovation is the fast track to the winner's circle!



NEW PRODUCT

# A FIRST-CLASS CATCH

## BRISTOL TRAWLER

Ready-To-Run Electric Fishing Boat



- LiPo-ready
- Tactic TTX490 4-channel 2.4GHz SLT radio with TR400 receiver
- Powered by a 550-size motor and 30A LiPo-ready brushed/brushless ESC with stutter bump
- Lots of scale detail, including working lights, coiled rope on the sail winch drums and more
- Painted fiberglass hull and fully rigged masts trim final assembly time
- Display stand included



Enjoy up to an hour of run time with the recommended LiPo battery\*!

\*LiPo battery sold separately.

### AQUB5720 Bristol Trawler Electric Fishing Boat RTR

**Hull Length:** 33.5 in (851 mm)

**Width:** 8.75 in (222 mm)

**Total Height:** 29 in (737 mm)

**Weight:** 7 lb (3.2 kg)

**Requires:** 11.1V 2200mAh LiPo battery, charger & 6 "AA" batteries

**AQUACRAFT**<sup>®</sup>  
Models

### From the Experts:

You'll feel like a real fishing boat captain at the helm of the Bristol Trawler! Attention to detail is evident throughout, with scale touches that lend a very authentic appearance. The 30A ESC is LiPo-ready, with a stutter bump that lets you safely dock your vessel before power runs out.

### Long story short...

*The Bristol Trawler looks and performs so much like a real fishing vessel, all that's missing are the fish!*

# A CLASSIC AEROBATIC GREAT!

## Citabria

Almost-Ready-To-Fly 30cc Sport Plane

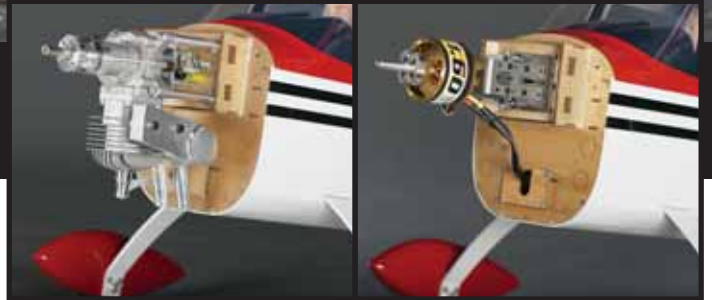

The Citabria is an outstanding aerobat, whether it's powered by a 30-35 cc gasoline engine or a 1.60 brushless outrunner motor.

- Balsa and ply construction with self-aligning tail surfaces.
- Magnetically secured removable front windscreen.
- Two-piece wing with joiner tube
- Flaps and ailerons are pre-hinged.
- Painted fiberglass cowl and painted fiberglass wheel pants.
- Molded seat backs cover onboard gear and provide seating for an optional pilot figure
- MonoKote covering

GPMA1435 Giant Citabria 30cc ARF

Wingspan: 85 in (2160 mm)

Wing Area: 1168 in<sup>2</sup> (75.3 dm<sup>2</sup>)

Weight Range: 14.5-16.5 lb (6.57-7.48 kg)

Wing Loading: 29-33 oz/ft<sup>2</sup> (88-101 g/dm<sup>2</sup>)

Length: 62 in (1575 mm)



### From the Experts:

You can sum up the Great Planes Giant Citabria in one word: easy. Its big-plane size makes it easy to track in the air, without giving up the small-plane assembly conveniences you appreciate. Built-in flaps and ailerons make it easy to enjoy the plane's full aerobatic potential — and it's priced to be easy to afford.

### Long story short...

*Great Planes' 85" wingspan Citabria replicates the versatile full-size flyer in both looks and performance!*



# THE FUTURE OF COMPETITION BUGGY TECHNOLOGY IS HERE

Area 51 designers took on the daunting task of improving upon the 11-time IFMAR World Champion RC10 — and they came up with not one but TWO worthy successors! The RC10B5 Team Kit boasts a long list of upgrades for

taking this buggy's performance and fine-tunability to the next level, and it's available in both a standard rear motor mount position chassis and a dedicated mid-motor chassis version.



1/10 Scale 2WD Electric Off-Road Competition Buggy Kit



1/10 Scale 2WD Electric Mid-Motor Off-Road Competition Buggy Kit



**Both kits share all of these advantages:**

- Narrow composite tub chassis with optimized motor position and metric hardware
- Compatible with ROAR-approved 2S saddle, short and square packs
- Factory Team V2 12mm Big Bore threaded aluminum shocks with 3mm shafts
- Factory Team VTS (Variable Torque Slipper) with three drive surfaces and high-res spring
- Stronger transmission gears, precision ball bearings and a 14 carbide ball diff
- New easier-to-adjust front suspension featuring heavy-duty steering and caster blocks
- Kick-up angle options of 25° and 30° are included
- One-piece front axle/hex adapter and larger front wheel bearing
- Lubricated ball cups and optimized ball studs for maximum suspension travel with minimal binding and friction
- Updated full bearing steering system for finer Ackermann adjustments
- Rear hubs with larger bearings and easy insert system for quicker camber link and rear toe-in adjustments
- Clear B5 body and wing included

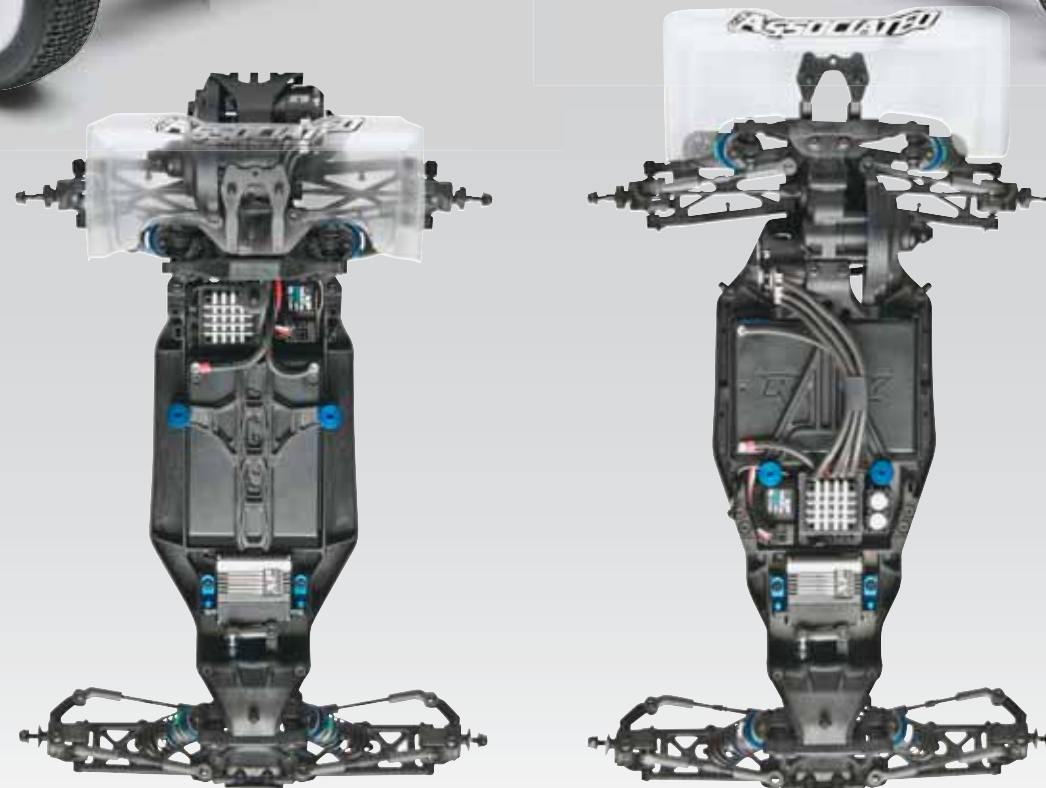

ASCD9001 RC10B5 Team Kit  
 ASCD9003 RC10B5M Team Kit  
 Length: 15.2 in (385 mm)  
 Width: \*  
 Weight: \*  
 Wheelbase: 10.98-11.06 in (279-281 mm)  
 \*Final width and weight contingent upon electronics and tires.

Both versions feature a narrow tub chassis; the RC10B5M's mid-motor design maximizes the buggy's handling on high-speed, high-grip tracks.



12mm V2 Big Bore threaded shocks

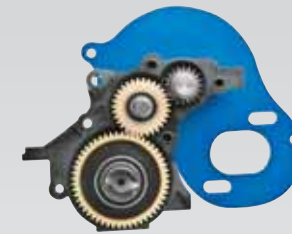

New transmission has stronger gears, precision ball bearings and a 14 carbide ball differential. Transmission shown is for the RC10B5.



VTS slipper clutch



Adjustable front suspension mount angle kick-up options of 25° and 30°.



Steering and caster block insert system allows for easier caster and trailing axle adjustments.

# THREE GREAT LOOKS — ONE HIGH-PERFORMANCE PLATFORM

## Sprint 2 FLUX



HPID6458



HPID6460

HPID6463

Here are 3 fast ways to get started in 1/10 scale, 4WD touring. All are factory-assembled, fully waterproof and powered by a Flux Vapor brushless motor system. Because they're all built on the Sprint Flux 2 chassis, you can custom tune handling to your own style or track conditions. And all three are topped off with painted, trimmed, mounted and officially licensed bodies.

### All share these extraordinary features:

- Efficient belt-driven 4WD
- HPI Flux Vektor 5900kV brushless motor
- Waterproof HPI Flux Vapor ESC with LiPo safety cut-off
- Waterproof SF-10W steering servo
- Waterproof receiver box
- Orange anodized aluminum chassis parts
- Officially licensed Rays/Volk TE37 wheels
- HPI X-Pattern rubber tires for realistic appearance and great handling
- Foam bumper
- Adjustable body posts
- Adjustable turnbuckles for fine-tuning suspension
- Complete set of ball bearings
- Oil-filled coil-over shocks
- 2° and 3° rear hubs for additional tuning
- Durable injection-molded nylon chassis
- Shock towers with optimized shock and camber link positions
- Droop screws for "race tuning" suspension settings
- Precise bellcrank steering
- 2.4GHz radio system for crystal-free control
- Authentic licensed replica racing bodies

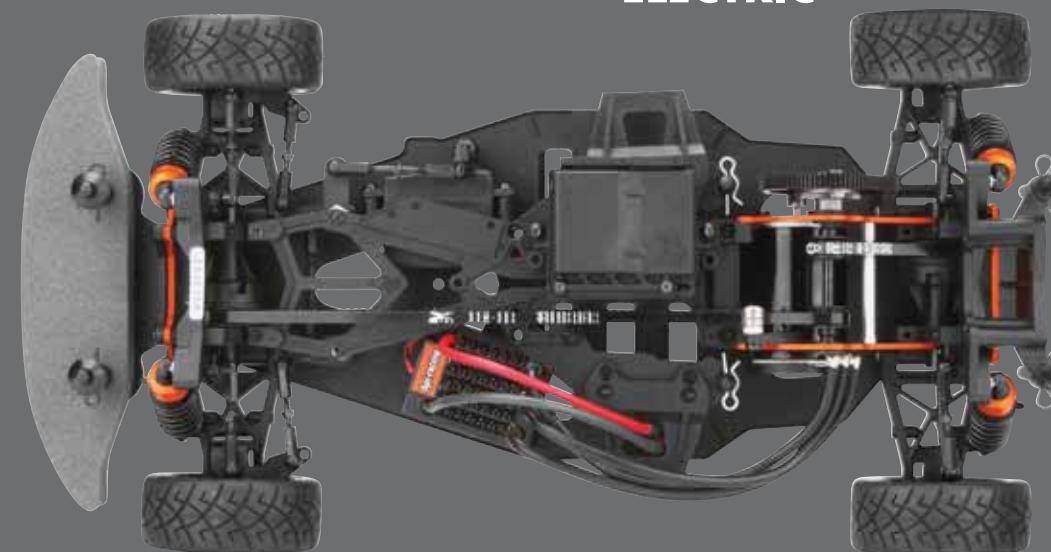

HPID6458 Sprint 2 Flux BMW GT-2 RTR  
 HPID6460 Sprint 2 Flux Mustang GT-R RTR  
 HPID6463 Sprint 2 Flux 2010 Camaro Body RTR  
 Length: 17 in (431 mm)  
 Width: 7.9 in (200 mm)  
 Wheelbase: 10 in (254 mm)  
 Requires: 7.2V battery with Dean's plug and charger

Chevrolet, Camaro, all related Emblems and vehicle model body designs are General Motors Trademarks used under license to HPI

The BMW logo and the BMW wordmark are trademarks of BMW AG and are used under license

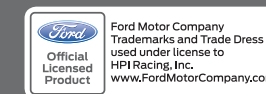

# NO OTHER SC TRUCK COMES CLOSE TO THE DESC210R

## DESC210R

1/10 Scale 2WD Electric Short Course Truck Kit



Short Course is the hot category in R/C truck racing, and Team Durango is leading the way with the DESC210R. With its Hybrid Technology gearbox design that allows for seamless positioning of the motor (mid, rear, left, right), the DESC210R stands out as arguably the most tunable yet driver-friendly pro electric 2WD truck kit ever designed. And by equipping your model with the high-performance completer parts listed below you'll enjoy an even bigger advantage over the competition!

### Futaba

S9551 Digital Low-Profile High-Speed/Torq Servo  
FUTM0661

R614FS 4-Channel 2.4GHz FASST Receiver 4PKS  
FUTL7635

### TrakPower

SPEED EQUIPMENT

175T Stock Sensored Brushless Motor  
TKPC5045

MS-1 100A Sensored Brushless ESC  
TKPM0010

LiPo 2S 7.4V 5600mAh 90C Hard Case 5mm  
TKPC0616

### Duratrax

Shotgun SC Tire C2 (2)  
DTXC3786

TDR0030 DESC210R 1/10 Scale 2WD Electric Short Course Truck Kit  
Length: 21.4 in (544 mm)  
Width: 11.4 in (290 mm)  
Wheelbase (adjustable): 12.6-13.0 in (321-329 mm)  
Approx. Weight w/electronics: 4.4 lb (2.0 kg)  
Truck shown with option parts not included in the kit.



# GET AMAZING AIRPLANES AND FANTASTIC FREE MERCHANDISE!

**HURRY!**  
This offer ends  
August 31, 2014!



the really **big** airplane rebate



There's no better way to kick off the R/C flying season than with a new airplane — and now you can get FREE MERCHANDISE too! The Really Big Airplane Rebate features over 85 top-of-the-line ARFs, RTFs, Tx-R and Rx-R models, and when you purchase one by August 31, 2014, you'll be eligible to receive a certificate worth UP TO \$50 towards quality R/C products from over 30 popular brands!

With so many airplanes to choose from — including electrics, glow-powered, sport models, aerobats, warbirds and giant scale — you're sure to find your favorites from top brands such as Great Planes, Flyzone and Top Flite. And just imagine what you can do with a merchandise certificate worth up to \$50!

Visit your participating hobby retailer NOW and get more than just a great airplane: get quality R/C merchandise for FREE!

### Over 85 airplanes included

To see the complete list, go to BestRC.com and click on the Really Big Airplane Rebate banner. You'll also find all the information about the event, as well as a downloadable Merchandise Certificate request form.



**\$50**

Great Planes Yak 55M  
50-55cc ARF  
GPMA1230



**\$30**

Great Planes Super Stearman ARF  
GPMA1350



Top Flite Giant P-51D Mustang ARF  
TOPA0700



**\$15**

Flyzone Switch 2-in-1 Tx-R  
FLZA3302



**\$10**

Flyzone Tidewater Seaplane RTF  
FLZA3330



**\$5**

AirCore Me-109 Airframe  
FLZA3906



©2014 Hobbico®, Inc. Void where prohibited. Some terms, conditions and restrictions apply, and only while supplies last. Available only at participating local hobby shops in the U.S. and Canada. Rebates apply to purchases made between June 15 and August 31, 2014. Rebates are not distributed in stores. Official rules and downloadable rebate request forms and are available at BestRC.com. Rebate requests must be submitted by September 30, 2014. All trademarks are the property of their respective owners.

# ACT NOW TO GET A FREE TACTIC RECEIVER!

Create a great radio system and SAVE! When you buy a Tactic TTX650 through August 31, 2014 you'll also receive a TR625 6-channel 2.4GHz twin antenna receiver AT NO EXTRA CHARGE!

## FREE!



### A \$44<sup>99</sup> retail value!

TR625 6-Channel 2.4GHz Twin Antenna Receiver  
TACL0625



### TTX650

6-CHANNEL SLT COMPUTER RADIO

TTX650 6-Channel 2.4GHz Computer Radio  
TACJ2650

## TACTIC™

©2014 — Hobbico®, Inc. This offer is available only to residents of the U.S. and Canada, and only from participating hobby shop. Items are subject to availability with no substitutions. Ask your participating hobby shop for details.

# GET FREE MERCHANDISE WITH R/C'S BEST BUGGIES!

Experience the nitro-powered realism of the 835B — or the brushless electric speed and performance of the 835E — and enjoy a \$40 spending spree at your hobby shop! All you have to do is purchase either one of these exciting Ready-To-Run buggies by August 31, 2014, and you'll receive a certificate worth \$40 towards quality merchandise from over 30 top brands!

## \$40 Mail-in Merchandise Certificate



**835B Nitro Buggy**  
DTXD72\*\*



**835E Electric Buggy**  
DTXD78\*\*



©2014 — Hobbico®, Inc. Void where prohibited. Some terms, conditions and restrictions apply, and only while supplies last. Available only at participating local hobby shops in the U.S. and Canada. Rebates apply to purchases made between June 15, 2014, and August 31, 2014. Rebates are not distributed in stores. Official rules and downloadable rebate request forms are available at BestRC.com. Rebate requests must be submitted by September 30, 2014.

# IT'S THE LAST MONTH FOR THIS SPECIAL OFF-ROAD OFFER!

Purchase an Axial SCX10 Trail Honcho or Jeep Wrangler RTR through August 31, 2014, and you'll receive a FREE Onyx NiMH battery — THE recommended power pack for getting the most out of these versatile machines!



## SCX10 Trail Honcho RTR

Tame the badlands with power and performance!  
AXID9022



## SCX10 Jeep Wrangler RTR

Go overland with true Jeep Wrangler style!  
AXID9028

# FREE!

## Duratrax Onyx 7.2V 3000mAh NiMH Battery

The ideal sport pack for cars, trucks and boats!  
DTXC2055



A **\$31.99** retail value!



©2014 — Hobbico®, Inc. This offer is available only to residents of the U.S. and Canada, and only from participating hobby shop. Items are subject to availability with no substitutions. Ask your participating hobby shop for details.

Jeep and related logos, vehicle model names and trade dresses are trademarks of Chrysler Group LLC and are used under license by Axial R/C Inc. © Chrysler Group LLC 2014.

# DON'T MISS THIS GREAT AQUACRAFT OPPORTUNITY!

Through August 31, 2014, when you purchase a select AquaCraft model you'll be eligible to receive a certificate worth up to \$25 that you can spend on quality merchandise from over 30 top brands!

**\$15** Mail-in  
Merchandise Certificate

AQUB01\*\* Paradise FRP Sailboat RTR  
AQUB60\*\* Bristol Bay Fishing Boat RTR

**\$25** Mail-in  
Merchandise Certificate

AQUB59\*\* Atlantic Harbor Tugboat RTR  
AQUB0200 Vela One-Meter Sailboat 2.4GHz RTR  
AQUB5700 Rescue 17 Fireboat RTR



AQUB0200



©2014 — Hobbico®, Inc. Void where prohibited. Some terms, conditions and restrictions apply, and only while supplies last. Available only at participating local hobby shops in the U.S. and Canada. Rebates apply to purchases made between June 15, 2014, and August 31, 2014. Rebates are not distributed in stores. Official rules and downloadable rebate request forms are available at [BestRC.com](http://BestRC.com). Rebate requests must be submitted by September 30, 2014.

TURN HERE FOR GENERAL HOBBY PRODUCTS



# REVELL® EXPANDING MODEL KIT LINEUP

## Putting it all together for a new generation



Revell continues to introduce innovations in its plastic model lineup. This month, Great Planes speaks with Revell Vice President and General Manager Lou Aguilera about the new model kits being introduced this month. Here's what makes them perfect for new modelers and for modelers who've been out of the hobby for a while.



**GPD:** What's the latest news about Revell's product line expansion?

**Lou:** As you know, in June we announced the first of many new SnapTite® products. The June introductions were developed to engage builders as young as 6 years old. Now we're expanding our line and our market further, with models that are more advanced than SnapTite but are also simpler to build and decorate than traditional model kits.

**GPD:** What led you to add this new model kit category?

**Lou:** Our research showed that inexperienced builders find traditional glue kits too challenging. This new line eases the transition from SnapTite to using glue and paint. We want to create products that give first time builders a favorable experience. We want them to be proud of the models they've built so they'll want to build more.

**GPD:** How do these new kits differ from the traditional kits?

**Lou:** This new category smooths the transition between SnapTite and advanced models. The models have roughly 45 parts, 70% fewer than most of our existing car kits. The bodies are molded in color and already decorated at the factory. Inexperienced builders don't have to attempt spray painting or airbrushing and don't have to handle water-slide decals. The clear windows are factory-decorated, too. They're also glued into position, removing the sometimes difficult step of installing windows.

**GPD:** In what ways are the new kits and traditional kits the same?

**Lou:** Like traditional kits, this new kit category provides detailed engines, interiors and chassis. They can all be brush-painted, if the modeler really wants to show off the high level of detail in the models.

**GPD:** The packaging style looks new, too.

**Lou:** That's right. Every one of these new kits comes in a window box that clearly displays its level of pre-decoration. The bottom right front panel shows the number of parts, what you'll need, and how long it should take. The back panel shows all the parts laid out and recommends paint colors. The box offers plenty of information about what to expect, so there's no guesswork.

**GPD:** So what's the appropriate age range for these new kits?

**Lou:** It's not so much about age as it is about skill. The primary market is a 10-11 year old with some experience in SnapTite or construction toy building. We also believe these kits will be a very good re-entry point for people who have not built a model in decades, but would like to work on a project for themselves or with a new generation.

**GPD:** What subjects are you offering?

**Lou:** The first two items we'll have in this line are the 2013 Camaro® ZL1™ and a 2013 Challenger SRT8. Both of these red-hot cars should be showing up in-store in late August. And, by the end of 2014, two more titles will be released.

**GPD:** Are new releases of traditional model kits still in your plans?

**Lou:** Yes! We love our hobby, so we will continue to develop higher-level kits for model enthusiasts. To continue building the modeling community, though, we need to generate new interest with products that help develop the skills needed for more challenging kits. This new category helps make the transition more achievable for a new group of hobbyists. Bringing in new hobbyists ensures we will all benefit from more selection and better products.



For new modelers, everything is clearly indicated, making shopping decisions easier: piece count, items needed for completion, and amount of time needed to build.

### Ford Features Revell Kits at OshKosh



Over half a million people from 60 countries flood into OshKosh, Wisconsin, each year for the largest airshow ever — the International Experimental Aircraft Association's "AirVenture OshKosh". This year's show starts July 28 and will be a week to remember, with 10,000 aircraft flying in. There are nightly concerts, entertainment, aerobatics, special attractions, workshops, demonstrations and much more.



Ford Motor Company will be among the hundreds of exhibitors present. In addition to showcasing the new 2015 Mustang GT, Ford's booth will feature a Revell "Make 'N Take" activity area. There, thousands of young kids will be able to build their own Revell 2015 Ford Mustang GT SnapTite model — and get their exciting first taste of the model building hobby.

The response that followed the release of this model kit last month has been incredible! Watch for three more SnapTite Build & Play kits to be released by Revell before the end of 2014.

www.gpdealer.com



## 2013 CAMARO® ZL1™ Precision Power



One look at the Camaro® ZL1™ and you're hooked. It's beautiful. Then, if you're lucky, you get a look under the hood at the 580 horsepower V-8. The price tag on the full-size original sits right in the "maybe one day, if I'm lucky" range. Until you are that lucky, have fun building this exquisite model! Kit features a pre-decorated body, fully-detailed 6.2 liter V-8 engine, and metal axles.

**RMXS4307 85-4307**  
**1/25 Camaro® ZL1™**  
**Total Parts: 48**  
**Length: 7.5 in (190.5 mm)**  
**Age: 10+**

Look what else can be done with a Revell SnapTite Build & Play kit in the hands of an experienced modeler!

As seen in the August issue of Scale Auto magazine, modeling expert Bob Downie literally transformed his Revell 2015 Mustang GT, creating a tribute to the Mach 1 trimmed in Silver Jade from 1969. His step-by-step, photo illustrated instructions show all the modeling tricks he used to build his display-ready masterpiece. For a little inspiration, check it out!

## 2013 CHALLENGER SRT8 HEMI Power



With a zero to sixty in just four seconds, the 2013 Challenger SRT8 is one of the fastest production pony cars. And, with the 2013 topping out at 180, there's nothing left for the 1970's model to do but eat dust.

**RMXS4308 85-4308**  
**1/25 2013 Challenger SRT8**  
**Total Parts: 44**  
**Length: 7.9 in (200 mm)**  
**Age: 10+**

This Revell SRT8 model features simplified glue assembly, some brush painting, a molded in color body, rolling wheels on metal axles, and a detailed V-8 engine.

### Long story short...

Revell's new kits give modelers the chance to build a plastic model with moderate challenges. Whether you're a young hobbyist with a couple of SnapTite® kits under your belt — or an experienced modeler who would just love a quick build on a hot new car — these kits are perfect! They require glue assembly and, if desired, brush painting can help show off the built-in details. They feature detailed engine, interior and chassis; rolling wheels; lowered parts counts; molded-in color; installed windows; and pre-decoration at the factory.





**1/25 1970 FORD® TORINO GT 2N1**  
Lean, mean racing machine

Built fresh for the new decade, the 1970 Ford Torino GT was a great leap forward from the previous model years. It won the "Car of the Year" trophy and was an instant mark of pride in any garage. Its engine, a 429 c.i. V8, was rated at nearly four hundred horsepower, giving it more than enough 'go' for any drag strip. **Kit features** photo-etched parts, drag racing engine and interior, choice of two sets of wheels and full decals.

85-4099    RMXS4099    Total Parts: 139    Skill Level: 3    Length: 8.3 in (210 mm)



**1/25 1957 CHEVY® CONVERTIBLE**  
The Boys to beat

Smaller, lighter, more aerodynamic, and easier to maintain than the cars of its day, the 1957 Chevy was a staple of the NASCAR circuit, club races, and the drag strip. Its overhead-valve V8 small-block engine produced 162 horsepower. When equipped with a 4-speed manual transmission, the '57 Chevy could leave the opposition in the dust. Even the convertibles, usually slower because of wind drag, were able to win all 3 stock car racing driver championships for the convertible class. **Kit features** convertible top and dual carbs with "bat-wing" air cleaner.

85-4270    RMXS4270    Total Parts: 162    Skill Level: 3    Length: 8.1 in (206 mm)



**1/24 LaFERRARI**  
Highest performance hybrid

Ferrari's first venture into the hybrid market is a stunning success. Equipped with a standard V12 gasoline engine and a Kinetic Energy Recovery System (KERS), the LaFerrari's combined drivetrain can deliver 950 horsepower. That extraordinary amount of power makes the LaFerrari the fastest street-legal car Ferrari has ever produced. Just under five hundred of these carbon-fiber constructed marvels will be sold to buyers willing and able to meet the 1.5 million dollar price tag. **Kit features** full-detail V12 engine, 7-speed transmission, and lift-off rear section.

85-4332    RMXS4332    Total Parts: 141    Skill Level: 3    Length: 7.7 in (195 mm)



**1/25 1967 CAMARO™ SS™ 2N1**  
Superior speed

The SS badge on the 1967 didn't actually stand for 'superior speed' but with this Camaro's Big Block 396 c.i. engine, it could have! This massive engine delivered between 350 and 375 horsepower depending on specific model. The endless options available for the '67 Camaro appealed to buyers with nearly 35,000 SS models rolling off assembly lines and onto American roads. **Kit features** a detailed 396 c.i. engine with optional dual exhaust, stock and racing wheels, racing interior, roll bar and separate back seat.

85-4936    RMXS4936    Total Parts: 130    Skill Level: 3    Length: 7.3 in (186 mm)

### 1/24 STREET FIGHTER®

Designed by Tom Daniel!

Tom Daniel's at it again, taking a classic '60 Chevy® delivery sedan – and turning it into the Street Fighter Super Car Killer! **Kit features** a Camaro Z/28 engine, a tilt-up front end, a racing steering wheel, plush boat-type buckets, a custom "GO" pedal, a reverse-flow hood scoop, front end spoilers, chrome-plated accessories, wide black vinyl tires, mag wheels, a roll bar and more.

85-4262    MONS4262    Total Parts: 72    Skill Level: 2    Length: 8.4 in (215 mm)

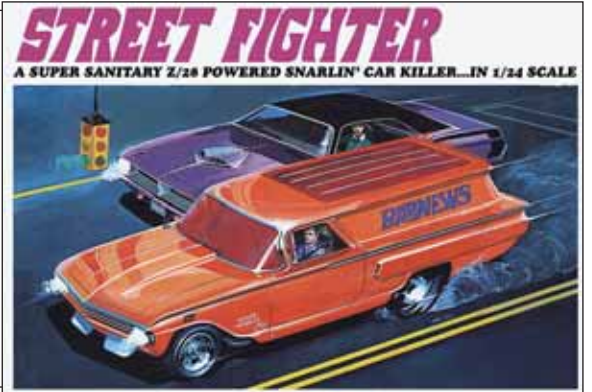

## REVELL OF GERMANY®



### 1/72 SCALE GTK BOXER GTFZA1

Germany's newest 'gepanzer'

At over 30 tons, the Boxer armored fighting vehicle is heavier than most tanks of World War II. It is designed as a modular system—capable of fulfilling multiple mission roles. Its primary function is to serve as an infantry transporter. It can carry an eight-man fire team into combat, protected by AMAP composite armor and then deliver fire support with a remotely operated automatic 40mm grenade launcher. The vehicle's combat effectiveness is currently being studied in operational units fighting in Afghanistan. **Kit features** four decal sets and optional armament.

03198    RVLS3198    Total Parts: 119    Skill Level: 4    Length: 4.4 in (111 mm)



### GERMANY® 1/144 EUROFIGHTER TYPHOON TWINSEATER

Learn to fly Europe's finest fighter

After thirty years in development, the Eurofighter Typhoon is making its way into Europe's air forces. It's well worth the wait. State-of-the-art pilot voice interaction systems make the Typhoon easier to control than the average fighter while the plane's agility and top speed exceeds that of many fighter jets. All that new tech requires training. A two-seat configuration allows students to learn the sticks from an experienced instructor. **Kit features** a two-seat version of the Eurofighter Typhoon with missiles, bombs and decals for the German and British Air Forces.

04879    RVLS4879    Total Parts: 83    Skill Level: 3    Length: 4.4 in (111 mm)



### 1/700 USS FLETCHER (DD-445)

Sail with the South Seas' supreme shore striker!

World War II had no shortage of exceptionally valiant and extremely active ships and crews. The USS Fletcher was amongst the greatest of them all. With fifteen battle stars and more than a few subs sent to the bottom, the officers and crew of the USS Fletcher were amongst the saltiest sailors in the US Navy. Their ship participated in numerous naval battles, gave covering fire to amphibious landings, and provided invaluable anti-aircraft fire. **Kit features** waterline hull, two lifeboats, armament, and decals for USS Fletcher and USS Chevalier.

05127    RVLS5127    Total Parts: 70    Skill Level: 3    Length: 6.46 in (164 mm)

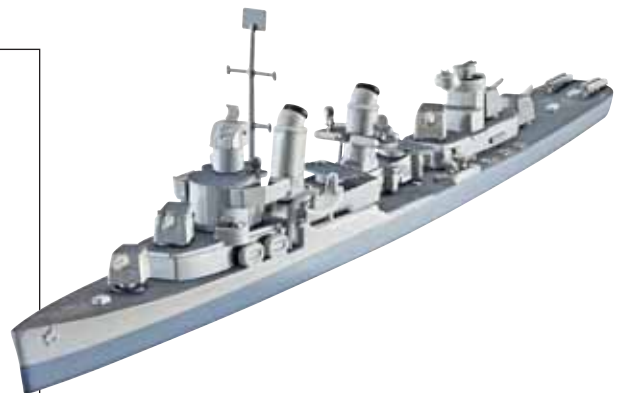



### 1/24 1953 CORVETTE® ROADSTER

America's first sports car

By 1953, low-slung high-performance sports cars had already been a staple of the European car market for years. Yet America simply didn't have anything to match them... until the Corvette was released. Only three hundred cars were produced in the first year, but they were a hit. This shapely and exceptional car could and did challenge the dominance of the European manufacturers, starting a line of beautiful cars that has continued for sixty years. **Kit features** separate, moveable hood, multi-part six-cylinder engine, instrument panel, structured seats, authentic reproduction white-wall tires, and full decals.

07067    RVLS7067    Total Parts: 91    Skill Level: 4    Length: 7 in (177 mm)



### 1/72 SCALE LOCKHEED MARTIN® F-35A LIGHTNING II PROTOTYPE

The fighter of the future

In years to come, aerial warfare will change as more sophisticated weapons emerge. The F-35 is an airframe intended to counter improvements in detection and engagement systems. It is a multi-role fighter designed with stealth capabilities which are intended to improve its survivability in a world swarming with SAM batteries. Long before the planes were operational, the System Development and Demonstration group was hard at work putting the prototypes through their paces. Limited edition **kit features** USAF "System Development and Demonstration" decals.

02107 (Limited Edition)    HSGS0207    Total Parts: 72    Skill Level: 3



### 1/72 SCALE MIKOYAN-23 AND MIKOYAN-27 FLOGGER COMBO (2KITS)

Seventies-era Soviet Strikers

Developed during the seventies as a "third generation" fighter interceptor, the Mikoyan-23 was designed with variable-sweep wings to improve its ability to take off with large loads of ordnance. The huge numbers of "Floggers" built were eventually outclassed by the fourth generation of fighters and many were converted to the Mikoyan-27 fighter bomber standard. These aircraft carried improved targeting systems for attacking ground targets and were available in the closing days of the Soviet-Afghan war. This limited edition **kit combo features** two models, each with two sets of decals.

02108 (Limited Edition)    HSGS0208 (2Kits)    Total Parts: 54 + 73    Skill Level: 3



### 1/72 SCALE P-3C ORION "JMSDF FLEET AIR WING 5"

The JMSDF's preferred patrol plane

The Japanese Maritime Self-Defense Force (JMSDF) has used the P-3 Orion for Pacific patrols since the 1980s. The JMSDF currently has over 100 P-3Cs at its disposal, so it's obvious their pilots approve of this maritime marvel. Fleet Air Wing Five, which consists of two separate squadrons, flies P-3C Orions from its headquarters at Naha Air Base. This limited edition **kit features** two decal marking options: 1. JMSDF Fleet Air Wing 5 VP-9, Code: 5044, Naha AB and 2. JMSDF Fleet Air Wing 5 VP-5, Code: 5051, Naha AB.

02109 (Limited Edition)    HSGS0209    Total Parts: 145    Skill Level: 3

### 1/72 SCALE F/A-18E SUPER HORNET "CHIPPY HO" Deliver destruction with the dynamite "Dambusters."

The "Dambusters" transitioned to the F/A-18E Super Hornet in the fall of 2010, becoming the first US Navy fighter wing to have its fleet consist solely of Super Hornets. VFA-195, which has prided itself on being able to deliver massive amounts of ordnance on target and on time ever since WWII, uses the Super Hornet's increased ordnance capacity, range and improved radar to combat the enemies of the United States. Currently the wing is stationed on CVN-73 USS George Washington. This limited edition **kit features** decals for VFA-195.

02111 (Limited Edition)    HSGS0211    Total Parts: 118    Skill Level: 3



### 1/72 SCALE RENZAN WITH GUIDED BOMB AND SHINDENKAI (2 KITS)

The threat that never was

By 1944, Japan desperately needed aircraft that could turn the tide of WWII. The Renzan was a long-range heavy bomber perfect for smashing island airfields. It was also capable of delivering the I-Goh, a guided bomb intended to break American naval supremacy. To counter America's aerial superiority, Japan designed the Shindenkai—a pusher-style canard fighter armed with four 30mm cannon. Fortunately, most of these designs never left the ground. You can own all three of these remarkable weapons from one limited edition **kit combo that features** six sets of decals!

00987 (Limited Edition)    HSGS0987 (2Kits)    Total Parts: 110 + 42    Skill Level: 3



### 1/72 SCALE SU-35S FLANKER-E Further fitting-out the 'Flanker'

Technically, the Su-35S is a modified Su-27. But since the Su-35S is loaded with improved avionics, vectored thrust engines, additional hardpoints for weapons and more, it's practically a whole new airplane. Its Mach 2.25 speed and over 17,000 lbs (8,000 kg) of ordnance capacity is extremely impressive. Its speed, ordnance capacity and range are all greater than comparable American and European airframes. Even with all its impressive performance, the Su-35S is only intended as a stopgap for until Russia's fifth generation fighter is released. **Kit features** a display stand and decals.

01574    HSGS1574    Total Parts: 299    Skill Level: 3



### 1/12 SCALE YAMAHA® YZR500 (0WA8) Fly towards first with Team Lucky Strike Roberts

From 1973-2002, the Yamaha YZR500 led four 500 cc Grand Prix riders to ten world championships. One of the most famous riders to take the helm of the YZR500 was Wayne Rainey. For the 1989 season, Rainey rode for the Roberts team, placed first in the US, Germany and the Netherlands, scored 210.5 points overall and earned a second-place finish for the season. He would later win three championships in '91, '92 and '93. This limited edition **kit features** new brake caliper parts and decals for number 17, Wayne Rainey.

21710 (Limited Edition)    HSGS1710    Total Parts: 167    Skill Level: 3





### 1/72 SCALE KAWANISHI H6K5 TYPE 97 MODEL 23 Eyes and ears of the 901st Naval Flying Group

Designed as a larger version of the RAF's Short Rangoon, the H6K5 was a four-engine flying boat designed in 1934 and in production by 1936. The aircraft's 24-hour endurance and incredible range made it perfect for long-range recon and bombing strikes. Throughout the Sino-Japanese War and WWII the H6K was in service along quiet patrol sectors despite its increasing vulnerability to the newer generation of fighters. This limited edition **kit features** photo-etched radar parts, plus decal options for two 901st NFG aircraft.

02048 (Limited Edition) HSGS2048 Total Parts: 150 Skill Level: 3



### 1/72 SCALE F-14A TOMCAT "ACE COMBAT® RAZGRIZ" A favorite fighter, primed for electronic warfare

The F-14A Tomcat is one of the most-recognized – and most-admired – of all modern fighters. It's no wonder fans jumped at the chance to fly it in the best-selling video game, "Ace Combat 5: The Unsung War!" The fact that this popular combat flight simulator **features** dozens of licensed, authentically recreated fighters added a degree of realism few sims could match. This limited edition **kit features** display stand parts and one decal marking option: 1. Fighter Squadron "Razgriz," Ace Combat 5.

SP313 (Limited Edition) HSGS5213 Total Parts: 195 Skill Level: 3



### 1/72 SCALE SU-33 FLANKER D "ACE COMBAT® STRIGON" Realistic flight, fictional fun

Released in 2007, "Ace Combat 6: Fires of Liberation" centers on a war between the fictional Republics of Estovakia and Emmeria. What's unique about this combat flight simulator is that while the setting is fictional, the aircraft are realistically detailed recreations of today's most famous fighters. Thanks to Hasegawa, you can build the Su-33 with the Strigon Squadron design scheme featured in this popular game. This limited edition **kit features** display stand parts and two decal marking options: 1. Federal Republic of Estovakia, 9th TFS "Strigon" and 2. Crimson Wing.

SP314 (Limited Edition) HSGS5214 Total Parts: 204 Skill Level: 3



### 1/48 SCALE F-86F-40 SABRE "BLUE IMPULSE EARLY SCHEME" Admire an aerobatic classic

The JASDF's Blue Impulse Aerobatic Team has been wowing airshow crowds since its debut in 1960. The earliest F-86F Sabres flown by the team featured an eye-catching design scheme painted in blue, pink, silver and light blue. By 1961, Blue Impulse aircraft were sporting their signature blue and white colors that today's airshow fans know and love. This limited edition **kit features** one decal marking option: 1. JASDF Blue Impulse Aerobatic Team, early scheme, Code: 92-7872, 1963.

07381 (Limited Edition) HSGS7381 Total Parts: 79 Skill Level: 3

### 1/48 SCALE MESSERSCHMITT BF109F-4 "SUPER EXPERTEN"

Flown by the fiercest

It's no surprise that the Luftwaffe was so successful against the Russian Air Force. Luftwaffe aircraft were better, their pilots were better trained and even their ground crews were more effective. What's surprising is that Russian pilots continued going into combat against pilots like Gerhard Barkhorn (301 victories) and Günther Rall (275 victories). They, and the rest of JG52 (10,000 kills claimed), flew the Bf109 exclusively and undeniably effectively. This limited edition **kit features** new metal inlet supports and decals for Barkhorn and Rall's aircraft.

07379 (Limited Edition) HSGS7379 Total Parts: 74 Skill Level: 3



### 1/48 SCALE KAWASAKI® T-4 "RED DOLPHIN"

The JASDF's top-notch trainer

The Kawasaki T-4 has been trusted by trainees since its addition to the JASDF's fleet in 1988. The "Red Dolphin" trim scheme on this model was inspired by a T-4 that was specially painted to commemorate the 13th Flight Training Wing's fiftieth anniversary. This limited edition **kit features** three decal marking options: 1. JASDF 32nd Training SQ, Code: 808, Hamamatsu AB; 2. JASDF 31st Training SQ, Code: 797, Hamamatsu AB and 3. JASDF 13th Flight Training Wing, Code: 759, Ashiya AB.

07380 (Limited Edition) HSGS7380 Total Parts: 117 Skill Level: 3



### 1/700 SCALE JAPANESE AIRCRAFT CARRIER AKAGI

Hammer of the IJN

For six months, Akagi and the other carriers of the Japanese Navy were the terrors of the seas. From Pearl Harbor to the Indian Ocean, Japanese planes rained ordinance on Allied warships. The rate of damage these ships inflicted was severe, but it could not be sustained. At the battle of Midway a single bomb struck the Akagi, setting the bombs and fuel in her hangar deck alight and slowly burning out the ship. This **kit features** full decals. A wooden deck sticker and photo-etched parts (HSGS7152) are available separately.

49227 HSGS9227 Total Parts: 195 Skill Level: 3



### 1/700 SCALE WOODEN DECK AKAGI CARRIER

Detail up your deck!

Like many carriers of its day, the Akagi was designed with a wooden flight deck. Though it made carriers more vulnerable, a wooden flight deck reduced the topside weight of carriers and improved their sea-keeping. After fires started in Akagi's hangars at the battle of Midway, the flight deck became rapidly unusable. Now you can increase the detail and authenticity of your Akagi kit with this wooden deck! **Kit features** a pre-cut and shaped wooden deck with deck detailing.

72152 HSGS7152 Skill Level: 3

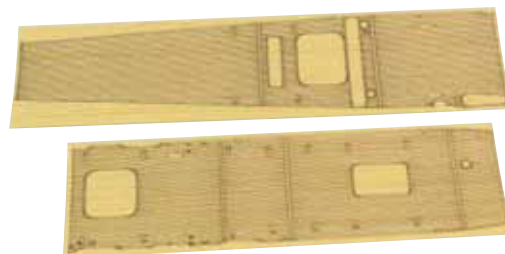





## AMT® 1/25 GM® Parts Pack

*Give it some gas!*

Build two of the greatest engines of the muscle car era from one kit! This kit comes with a custom and a competition version of the Chevy® 283 and Pontiac® 421! Either way, you've got the perfect modded engine to drop into any 1/25 scale car kit, or display the engine in all its glory on its own!

AMTPP011/24 AMTS0011 Total Parts: 59 Skill Level: 2

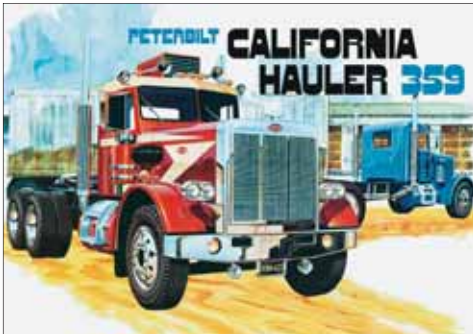

## AMT® 1/25 Peterbilt® 359 "California Hauler" Conventional

*It's big and it's back!*

Out of production since the 1960s, the beloved AMT Peterbilt 359 is back and ready to take the roads by storm! These big rigs have been a staple of the highway for decades. They're always going places, but they're never going away. Get yours before the tooling disappears for another fifty years! **Kit features** vinyl tires, dual rear axles with "Stablaire" suspension, full decals with optional stripes, and 'Retro Deluxe' Vintage packaging.

AMT866 AMTS0866 Total Parts:250+ Skill Level: 3 Length: 11.25 in (286 mm)



## AMT® 1/16 1965 Ford® Mustang Hardtop

*Saluting 50-years of Mustangs*

For fifty years, the Mustang has graced American roads with unmatched performance, reliability, and style. This model is a salute to the car that started it all—the 1965 Mustang Hardtop. It was designed to keep consumer costs down, using existing parts to make production and maintenance easier. More than one million mustangs rolled off assembly lines and were sold in just eighteen months. **Kit features** opening doors and hood, folding seats, stock and "Cobra" engine options, wheel options, vinyl tubing for motor ignition wire and radiator hoses, expanded original decal sheet, and 50th anniversary packaging.

AMT872 AMTS0872 Total Parts:134 Skill Level: 3 Length: 11.5 in (292 mm)



## AMT® 1/25 Lowboy Trailer

*Hauling the heaviest*

Lowboy trailers are designed with one thought in mind—hauling anything and everything that a normal semi-trailer can't. Cranes, excavation equipment, transformers, and more are all too tall to fit on a regulation height semi-trailer. Lowboys, with their much lower ground clearance, keep the center of gravity for these massive loads low while also ensuring that the tall items can pass under the nation's many overpasses. **Kit features** 12 vinyl tires, triple transformer load, Art print of original box painting, and Retro Deluxe packaging.

AMT880 AMTS0880 Total Parts:216 Skill Level: 3 Length: 19.25 (489 mm)



## Moebius® 1/25 1954 Hudson Hornet

*First and fastest*

Hudson Hornets were designed with 'step down' bodies. Passenger foot wells were slung lower than the chassis rails, keeping center of gravity low and giving the stock Hudson Hornet exceptionally potent performance. In fact, the Hornet was so far ahead of its contemporaries in performance that it won over half of the NASCAR® races conducted between 1952 and 1954. In addition, "Doc" Hudson, a character in the Disney® movie "Cars" was inspired by the Hudson Hornet. **Kit features** extensive detailing.

1213 MOES1213 Total Parts: 120 Skill Level: 3 Length: 8.25 (210 mm)

## Moebius® 1/25 1954 Hudson Hornet Special

*Specialty drag racer*

Hudson Hornets were designed with passenger foot wells were slung lower than the chassis rails, keeping center of gravity low. This gave the stock Hudson Hornet exceptionally potent performance. The 'special' fastback version of the '54 was a favorite drag racer of the 1960's. The fact that they were driven by just a six cylinder engine didn't detract from the fun of racing a Hornet around. The type won half the NASCAR® races of 1952-1954, proving they had more than enough power to blow anyone's hair back. **Kit features** extensive detailing.

1214      MOES1214      Total Parts: 120      Skill Level: 3      Length: 8.25 in (210 mm)



## MPC® 1/25 1975 Chevy® Chevelle Pepsi Stock Car

*Satisfy your thirst for victory*

The Chevy Chevelle was an iconic offering of the muscle car era, equipped with one of six optional engines coupled to one of three optional transmissions—it gave as much in power and comfort as it did in options. As good as it was on the open road, the Chevelle really showed its power on the NASCAR circuit. Incredible handling gave it the edge it needed to dominate the course from 1973 to 1977. **Kit features** V-8 racing engine, detailed interior, racing suspension, separate driver safety screen, full decals with Pepsi graphics, and vintage packaging.

MPC808      MPCS0808      Total Parts: 128      Skill Level: 2      Length: 8 in (203 mm)



## Polar Lights® 1/25 1966 Batmobile w/Batman & Robin figures

*BANG POW VROOM!!*

For three golden years in the mid-sixties, at least once a week American's could tune into a world where no criminal went unpunished and good always triumphed. Batman and Robin rushed in the Batmobile to comic misadventures in the campy, slapstick Batman series. The Batmobile was a nuclear-powered turbine-driven crime-fighting machine perfect for getting the dynamic duo to and from the bad-guy's hideouts quickly and in style. To the Batmobile! **Kit features** resin Batman and Robin figures, full decals, and photo box packaging.

POL920      PLLS0920      Total Parts: 122      Skill Level: 2      Length: 9.5 in (241 mm)



# Just Released

## Iwata® HP-B Plus Airbrush

*The Pro workhorse that will work for you!*

- Dual-purpose cutaway and pre-set handle for precise control
- PTFE needle for solvent-based paints
- Large-thread nozzle for secure fit and nozzle centering
- Single-piece auxiliary lever/ needle-chucking guide



**H2001  
IWAR3001  
HP-B Plus  
Airbrush**

## Kid Galaxy® GoGo Auto Fire Truck

*Perfect for the tiny-tot R/C enthusiast on your list!*

- Squeezable, soft, child-safe vehicle
- Two-button, 49 MHz radio controller
- Ages 2+



**10421  
KGRH0421  
GoGo Auto  
Fire Truck**



**SCM-165**  
**ELEX0165**  
Snap Circuits  
Motion

## Elenco® Snap Circuits Motion

*Set creativity in motion*

- Set up over 165 cool projects or design your own
- Experiment with the power of electricity
- Perfect for active minds 8 and over



**OSA276**  
**SLYX0276**  
Sports  
Science Kit

## Scientific Explorer® Sports Science Kit

*Step up your game with science!*

- Learn the science behind sports
- Fun activities that make you better on the field
- Perfect for active scientists 8+



**OWI-891**  
**OWIX0891**  
EM4 Robot Kit

## OWI® EM4 Robot Kit

*Domo Arigato, Mr. Roboto!*

- Design and build gear-action robots
- Includes parts and designs for four robots
- Transform your living room into a robo-rink!



**89975**  
**TAMX9975**  
Mechanical  
Blowfish  
Swimmer

## Tamiya® Mechanical Blowfish Swimmer

*This Blowfish is a hoot, eh!*

- Really swims in water!
- Easy snap-together assembly!
- Adjustable tail fin for swimming laps!
- Requires one AA battery (sold separately)



**WS58**  
**TEDX0058**  
Wild Science  
Spooky Ice  
Planet

## Tedco Toys® Wild Science Spooky Ice Planet

*Science so cool, it will give you chills*

- Create creepy crawlies and ghastly ghouls
- Explore the scientific properties of cold
- Experiment, explore, and excite imaginations!

## Uncle Milton® Frozen Wall Friends Olaf the Snowman

*A chilly friend to warm the room with light!*

- Talking Olaf has many Frozen sayings
- High and low brightness settings
- Auto shut-off for bedtime
- Remote control operated



**2519**  
**UMLX2519**  
Frozen Wall  
Friends Olaf the  
Snowman

## Alex Toys® Knot A Quilt

*Tie up loose ends and make something beautiful!*

- Make a 42 x 54 in. (1067 x 1372 mm) quilt the easy way!
- Fringed fleece squares tie together to form a quilt
- Six vibrant colors
- Make fun, useful quilts quickly and easily
- Recommended for Ages 6+



**383WN**  
**ALXY0383**  
Knot A Quilt

## Alex Toys® Lollipop Fashion Display

*Glam gear you can really sink your teeth into!*

- Counter display with four craft kits
- 'Candy' bangles, candy-wrapper beads, BFF bracelets and sweet nails
- Non-edible, but totally sweet!
- Recommended for ages 7 to 15



**174PDQ**  
**ALXY0174**  
Lollipop  
Fashion Display

## Balitono Works of Ahhh Dollhouse

*Decorate every doll's dreamhome!*

- Pre-patterned, hinged dollhouse with carrying handle
- Seven paint pots with two brushes
- Furniture and accessories
- Recommended for ages 5+



**21329**  
**BLTY1329**  
Dollhouse

## Balitono Works of Ahhh Express Train Set

*Get creativity rolling with the Express Train Set!*

- Pre-cut wooden train
- Five paint pots with three brushes
- Detailed decals
- Perfect for the aspiring engineer in your family!



**21430**  
**BLTY1430**  
Express  
Train Set

1137000  
CFKY1137  
Grow n' Glow  
Terrarium



## Creativity for Kids Grow n' Glow Terrarium

*Bring a little nature into your home!*

- Plastic Mason-style jar forms the basis of a little world
- Layer included rock, dirt, and seeds
- Add in included decorative animals and glow in the dark stickers

1855000  
CFKY1855  
Duct Tape  
Dragsters



## Creativity for Kids Duct Tape Dragsters

*Drag out some fun!*

- Trick out your pull-back dragsters with duct tape!
- Turn the box into a starting grandstands!
- Race day or night with glow in the dark duct tape!

C14  
EITY0014  
America  
Hot Rod



## Eitech® America Hot Rod

*Hot rod fun on hand!*

- All-metal construction!
- Inspire young engineers!
- Set builds three models and includes tools and step-by-step instructions

14594  
FBCY4594  
You Can  
Doodle

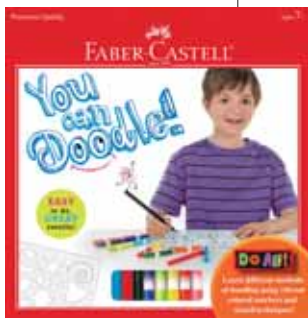

## Faber Castell® You Can Doodle

*Of course you can doodle!*

- Stencils
- Colored markers
- Instructions

60551  
MBEY6551  
Hard Pear  
Cider Refill



## Mr. Beer® Hard Pear Cider Refill

*Not your grandmother's pear juice.*

- Makes 2 gallons of hard pear cider in 2 weeks
- Smooth, refreshing, easy.
- Requires Mr. Beer Brewing Kit barrel.

## Whitman® Coin Books

*What's in your coin collection?*

- America's best-selling coin books
- Detailed information and pricing on tons of coins
- Photographs and historical details included
- Find out what your pocket change is really worth!

Also Available:  
WHCZ9545 0794842240 2015 Coin Blue Book

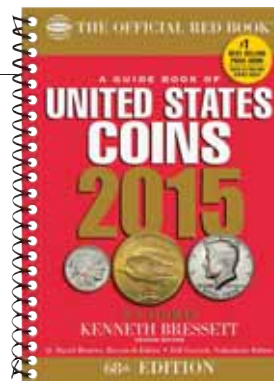

0794841805  
WHCZ1806  
Coin Red Book

## Royal & Langnickel® Acrylic Brush Painting Wooden Box Art Set

*Make something marvelous*

- Paints, brushes and more in an attractive wood case!
- Acrylic paints perfect for canvas and more!
- Paint where the inspiration is, take this set anywhere!



RSET-ACR2030  
RBM1650  
Acrylic Brush  
Painting Wooden  
Box Art Set

## Royal Brush® 21-Piece Sketching Set

*Drawn to drawing?*

- Artists' sketching and drafting pencils
- Graduated shade weights
- Convenient case



RART-200  
RBM1654  
21-Piece  
Sketching Set

## SunsOut Train Puzzles

*The perfect fit for train lovers*

- Elegant scenes with trains as the center focus
- 550 and 1,000 piece puzzles with full-color art-print fronts
- Eco-friendly soy ink puzzles on recycled board
- 100% Made in the U.S.A.!

**Great Planes  
Exclusive!**



49406 SOIY9406  
Coming and Goings at John Street 550pcs



21182 SOIY1182  
Travel by Train 1000pcs



21287 SOIY1287  
The Right Way 550pcs

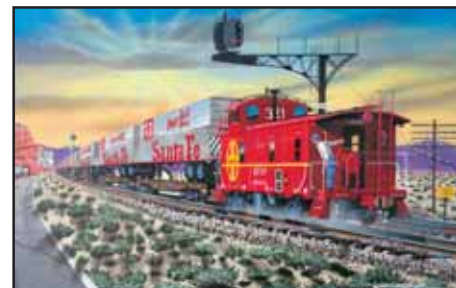

21329 SOIY1329  
Red Signals/Dust 1000pcs

# ESTES NITRO RTF

Ignite the nitro!

- Colorful, high flying mini engine powered rocket
- Includes 6 in (15.2 cm) pre-assembled parachute.
- RTF: Fully ready for launch!
- Requires engines, launch pad and controller, recovery wadding, starters, glue and launch controller batteries.

**Max. Altitude:** 425 ft (130 m)  
**Height:** 12.6 in (32 cm)  
**Diameter:** .74 in (19 mm)  
**Weight:** .69 oz (19.6 g)  
**Recommended engines:** 1/2A3-4T (first flight), A3-4T, A10-3T  
**2461**  
**ESTT2461 Nitro RTF**



Ready to Fly **RTF**



## Long story short...

*The Nitro is ready to blast off in minutes. No assembly required.*

# ESTES NOVA ARF

Shine bright with the Nova!

- Over 20 inches in length
- Use the BT-55 Booster Accessory (ESTT2257) for flights over 2,000 ft.
- ARF: Just slide on fins and attach the recovery chute.
- Requires engines, launch pad and controller, recovery wadding, starters, glue and launch controller batteries.

**Max. Altitude:** 700 ft (213 m)  
**Height:** 20.6 in (52.3 cm)  
**Diameter:** 1.33 in (34 mm)  
**Weight:** 2.5 oz (70.9 g)  
**Recommended engines:** B6-2 or B6-4 (first flight), C6-3 or C6-5 or D12-0 (if using the BT-55 booster accessory)  
**2497**  
**ESTT2497 Nova ARF**



Almost Ready to Fly **ARF**



ESTT2257 BT-55 booster accessory



## Long story short...

*In just a few simple steps, you will be ready to soar up to 700'!*



# ESTES ROCKETS: PERFECT FOR SCHOOLS AND YOUTH GROUPS

www.gpdealer.com



Estes Rockets have been used by over 30,000 teachers and youth group leaders to Ignite imaginations, combining fun with learning about math, science, propulsion, aeronautics and rocket history! Many scouts earn merit badges in rocketry, and many NASA engineers began as young model rocketeers.

Starting a model rocket program in your local school or youth organization is great way to inspire young people — and Estes Educator makes it easy and affordable!

### Convenient and Economical!

With Educator Discount Bulk Packs, you can get started quickly and without spending a lot. All you need for 12-24 students is:

**Bulk Pack Rockets + Bulk Pack Engines + Launch Set**

### Educator Bulk Pack Rockets

E2X Easy-To-Assemble Rockets - assemble in about 1 hour

- ESTT1715 1715 Color the Sky (12-pack)
- ESTT1751 1751 Alpha III (12-pack)
- ESTT1764 1764 Generic (12-pack)

Skill Level 1 Rockets - more model building required

- ESTT1722 1772 Comet Chaser (12-pack)
- ESTT1754 1754 Wizard (12-pack)
- ESTT1755 1755 Viking (12-pack)
- ESTT1756 1756 Alpha (12-pack)

### Educator Bulk Pack Engines

- ESTT1781 1781 A8-3 Engines (24)
- ESTT1783 1783 B6-4 Engines (24)
- ESTT1784 1784 B6-0/B6-6 Engines (12 of each)
- ESTT1788 1788 1/2 A3-4T Engines (24)
- ESTT1789 1789 C6-5 Engines (24)
- ESTT1672 1672 Blast-Off Variety Pack (6 ea A8-3, B6-4, C6-3, C6-5)

### Best-Selling Launch Sets

Launch Sets include Launch Controller and Launch Pad, plus one or two Rockets!

- ESTT1403 1403 Riptide Launch Set with E2X Rocket
- ESTT1427 1427 Alpha III Launch Set with E2X Rocket
- ESTT1462 1462 Shuttle Xpress Launch Set with E2X Rocket
- ESTT1469 1469 Tandem-X Launch Set with (2) Rockets
- ESTT1478 1478 Flash Launch Set with (2) Rockets
- ESTT1491 1491 Taser Launch Set with E2X Rocket
- ESTT1499 1499 Rascal/Hi Jinks Launch Set with (2) Rockets



### Need help choosing the right rockets for your program? Go to EstesEducator.com!

- Free Lesson Plans - all matched to National Learning Standards
- Automated Systems Display Items Needed
- Links to Funding and Grants
- Extensive Resources Online - videos, worksheets, curricula & more

### Use the pull-down menus to:

- Choose a grade level - Grades 3-5, Grades 6-8, or Grades 9-12
- Choose a subject - Science, Technology, Math, Social Studies or Language Arts
- Choose the number of classroom sessions - 1-Day, 2-Day, and 3-Day lesson plans available

*The perfectly matched lesson plan will be displayed - ready to download and print.*

### Determining the items needed is easy, too.

- Type in the number of students
- Check whether or not you already have Launch Equipment

*The web site automatically displays a list of items to purchase - no guesswork!*

### Estes Rockets are used by these outstanding youth programs:

- |                         |                           |
|-------------------------|---------------------------|
| Boy Scouts              | 4-H Clubs                 |
| Girl Scouts             | Christian Service Brigade |
| Awana Clubs             | Boys and Girls Clubs      |
| YMCA                    | After-school programs     |
| Civil Air Patrol Cadets | Royal Rangers             |

### Teacher Favorites:

For really unique rockets, check out these Teacher Favorites!

ESTT1260  
1260 Sky Writer - "write" in the sky with this clever-looking model

ESTT1948  
1948 Big Bertha - impressive looks, and an Estes original

ESTT1261  
1261 Baby Bertha - scaled down and easy to handle at 13" long

ESTT2178  
2178 Hi-Flyer - designed for extreme altitudes (over 1600 feet!)

ESTT1381  
1381 Yankee - a patriotic trim scheme with a unique nose cone

ESTT1949  
1949 Viking - with 48 possible fin configurations the Viking allows you to customize your rocket

ESTT1956  
1956 Firebolt - launch all kinds of fun items into the sky in the payload section

ESTT2123  
2123 Eggsaliber - transport your egg cargo in a see-through capsule

TURN HERE FOR RADIO CONTROL PRODUCTS

